

MEASURING UNIT



Part Number: NP52IGB
Revision: B.0

Copyright © April 2016 by Oldham S.A.S.

All rights reserved. The reproduction of all or any section of this document in any form whatsoever without the written permission of Oldham S.A.S. is forbidden.

The information contained in this manual is accurate to our knowledge.

As a result of continuous research and development, the specifications of this product may be modified at any time without prior notice.

Oldham S.A.S.

Rue Orfila

Z.I. Est – CS 20417

62027 ARRAS Cedex

Tel.: +33 (0)3 21 60 80 80

Fax: +33 (0)3 21 60 80 00

E-mail: info@oldhamgas.com

Website: <http://www.oldhamgas.com>

GAS DETECTION

We are delighted that you have chosen an **OLDHAM** instrument and would like to thank you for your choice.

We have taken all the necessary measures to ensure that your instrument provides total satisfaction.

Now it is important to read this document carefully.

EXTENT OF RESPONSIBILITY

- * **OLDHAM** declines its responsibility towards any person for material damage, physical injury or death resulting wholly or partly from inappropriate use, installation or storage of its equipment resulting from failure to observe instructions and warnings and/or standards and regulations in force.
- * **OLDHAM** neither supports nor authorises any company, physical or moral person to assume responsibility on behalf of **OLDHAM**, even if it is involved in the sale of **OLDHAM** products.
- * **OLDHAM** cannot be held responsible for direct or indirect damage or be required to pay direct or indirect compensation resulting from the sale or use of any of its products **IF THESE PRODUCTS HAVE NOT BEEN DEFINED AND CHOSEN BY OLDHAM FOR THEIR SPECIFIC USE.**

CLAUSES CONCERNING PROPERTY

- * Drawings, plans, specifications and information included in this document contain confidential information that is the property of **OLDHAM**
- * None of this information may be reproduced, copied, divulged or translated, by physical, electronic or any other means, nor used as the basis for the manufacture or sale of **OLDHAM** equipment or for any other reasons **without prior consent from OLDHAM**

WARNINGS

- * This document is not contractually binding. In the interests of its customers, **OLDHAM** reserves to modify the technical specifications of its equipment without notice, in order to improve its performance.
- * **READ THIS MANUAL CAREFULLY BEFORE FIRST USE OF THE EQUIPMENT:** this manual must be read by any person who is or will be responsible for using, maintaining or repairing this equipment.
- * **This equipment will only provide the announced performance levels if it is used, maintained and repaired according to OLDHAM directives, by OLDHAM personnel or by personnel approved by OLDHAM**

GUARANTEE

2 years guarantee in normal conditions of use on parts and technical labour, return in our workshops, excluding consumables (sensors, filters, etc.)

C O N T E N T S

1. INSTALLATION AND CONNECTIONS	7
1.1. INSTALLATION : RECOMMENDATIONS	7
1.2. ELECTRICAL CONNECTIONS FOR THE MX52 FACILITY (Fig.8)	7
1.2.1. AC supply	7
1.2.2. DC supply	8
1.3. THE SENSORS (Fig. 9 – Fig. 12)	8
1.3.1.. Explosimetric detectors of PONT type	8
1.3.2. 3-wire detectors 4-20 mA: 3 connecting wires for shielded cable	9
1.3.3. 2-wire detectors 4-20 mA: 2 connecting wires for shielded cable	9
1.3.4. FIRE detectors: 2 connecting wires for shielded cable	9
1.3.5. FLAME detectors: 2, 3 or 4 connecting wires for shielded cable depending on utilization	9
1.3.6. CO2 detector of type “Ventostat VT”	11
1.3.7. Specific case of CTX100 / COX 100 intrinsic safety detectors	11
1.3.8. Other detectors with standardized current output	11
1.3.9. Parking application	12
1.4. Connecting the unit to external devices	12
1.4.1. Slaving controls	12
1.4.2. 4-20 mA current outputs (Fig. 12)	13
1.4.3. RS 232 and RS 485 outputs	13
1.4.4. Remote acknowledgement	14
2. SWITCHING ON	15
2.1. CHECKING THE INSTALLATION	15
2.2. SWITCHING ON THE FACILITY	15
2.3. OPERATING MODES	16
2.3.1. Buzzer	16
2.3.2. Light-emitting diodes (LEDs) (fig26)	16
2.3.3. Alarm thresholds	16
2.3.4. The measurement facility	17
3. USE	19
3.1. LIST AND FUNCTION OF THE VARIOUS “USER” ELEMENTS FOR PROGRAMMING AND CALIBRATING THE FACILITY	19
3.1.1. The keypad (see Fig.26 and 4)	19
3.1.2. The maintenance keys	20
4. SCRAPPING OF MX52	21
5. SPECIAL SPECIFICATIONS FOR USE IN POTENTIALLY EXPLOSIVE ATMOSPHERES IN ACCORDANCE WITH EUROPEAN DIRECTIVE ATEX 94/9/EC.	23
5.1. SPECIFICATIONS FOR MECHANICAL AND ELECTRICAL INSTALLATION IN CLASSIFIED AREAS.	23

5.2.	METROLOGICAL SPECIFICATIONS	23
5.3.	CONNECTING DETECTORS OTHER THAN OLDHAM DETECTORS TO THE MX52 DEVICE	24
5.3.1.	Device transfer curves in 0% to 100% LEL configuration	24
5.3.2.	Device transfer curves in 0% to 30.0% OXYGEN configuration.....	25
5.3.3.	Power supply and load resistance characteristics.....	25
5.4.	MARKING	25
6.	VIEWS DEPICTED IN THE LEAFLET	29

1. INSTALLATION AND CONNECTIONS

Please ensure you read the paragraph: Special Specifications for use in Potentially Explosive Atmospheres in Accordance with European Directive ATEX 94/9/EC

1.1. INSTALLATION : RECOMMENDATIONS

The MX52 facility can be installed anywhere away from an explosive atmosphere. It should preferably be sited in a ventilated location under surveillance (guard post, control room, instrumentation room, etc.)

Fixing is carried out in accordance with the dimensions of Figure 1 (4 fixing points).

NOTE :

In order to be able to fully open the pivoting front panel of the facility, allow for opening by rotating 180° downwards.

To make any connections, switch off the facility using the general ON / OFF switch located at the bottom left of the FRONT circuit (see Fig.4 and Fig.26)

1.2. ELECTRICAL CONNECTIONS FOR THE MX52 FACILITY (Fig.8)

The facility is equipped with an automatic switching device for connecting to the 24 V DC voltage should the 220 V AC mains voltage be absent, and hence it is possible to use inexpensive backup power supplies.

1.2.1. AC supply

- Voltage : 230 V AC (207 to 224 V) 50/60 Hz
- Maximum power : 300 VA
- maximum current in the cable = 1.5 A
- Cable = 3 x 1.5 mm² (earth included)
- Location of connection terminals : Fig. 8 ref A
- Protection : the phase and neutral wires are protected by time – delay 2A fuses located at the rear of the power module (Fig.8 ref B)
- Voltage : 103 to 122 V AC – 50/60 Hz optional

ATTENTION

It is absolutely essential for the apparatus to be earthed. A terminal is reserved for this purpose at the rear of the power module : fig.5. this earthing is necessary to ensure the proper operation of :

- - the mains interference suppression filter
- - the devices for protection against electromagnetic interference.

1.2.2. DC supply

- Voltage : 21 to 30 volts DC. The “minus” of the DC supply is earthed (and the earth is linked to the chassis).
- Maximum power : 240 W
- Maximum current in the cable : 12.5 A
- Cable = 2 x 2.5 mm² or 2 x 4 mm² depending on the length.
- Location of the terminal : Fig.8 ref : D page
- Protection : via 2 fuses located et the rear of the supply module (Fig 8 – ref : E)

1.3. THE SENSORS (Fig. 9 – Fig. 12)

NOTE :

- The sensors are linked by SHIELDED cables.
- The use of shielded cables is OBLIGATORY
- The ground braid of the shielded cables must be earthed at one end

ATTENTION

Each channel has been configured in the factory for one type of sensor (explo. Gas, toxic gas, fire or flames).

Interchanging two types of sensor will lead to the destruction of the central board or of the sensor.

1.3.1.. Explosimetric detectors of PONT type

Three connecting wires for a shielded cable.

- Resistance of detector / unit cable: 16 ohms maximum per wire, i.e. 32 ohms in loop (1 km for cable 3 x 1.5 mm²).
- Connection on MX52 unit: see Fig. 10

1.3.2. 3-wire detectors 4-20 mA: 3 connecting wires for shielded cable

- Resistance of detector / unit cable: 16 ohms maximum per wire, i.e. 32 ohms in loop (1 km for cable 3 x 1.5 mm²).
- Connection on MX52 unit: see Fig. 10.

1.3.3. 2-wire detectors 4-20 mA: 2 connecting wires for shielded cable

- Resistance of detector / unit cable: 32 ohms maximum per wire, i.e. 64 ohms in loop (2 km for cable 2 x 1.5 mm²).
- Connection on MX52 unit: see Fig. 11.

1.3.4. FIRE detectors: 2 connecting wires for shielded cable

The current commercial designations are as follows:

- “Thermovelo” detectors of type EC 11 (sensitive to temperature variations)
- Ionic detectors of type EI 1 100 (sensitive to smoke)
- Optical detectors of type EO 1 100 (sensitive to smoke)

- Resistance of detector / unit cable: 28 ohms maximum per wire, i.e. 56 ohms in loop (2 km for cable 2 x 1.5 mm²)
- Fire detectors can be detected in parallel to a maximum of five. The end-of-loop resistor (2.7 K) is to be placed at the end of the line on the last detector.
- Connection on MX52 unit: see Fig. 11

1.3.5. FLAME detectors: 2, 3 or 4 connecting wires for shielded cable depending on utilization

REMARK

The detectors can be supplied with power either via the MX52 unit or by an auxiliary 24 V DC source.

These detectors can operate in standalone mode:

24 V DC power supply and direct utilization of relay contacts in accordance with the technical specification corresponding to the detector used.

The current commercial designations are as follows:

- model 20/20 U - analog - type UV - 752002 (sensitive to UV radiation)
- model 20/20 UC - analog - type UV (sensitive to UV radiation)
- model 20/20 UB - μ P technology - type UV - 772002 (sensitive to UV radiation)
- model 20/20 UBC - μ P technology - type UV (sensitive to UV radiation)
- model 20/20 LC - analog - type UV/IR (pyroelectric, combination of UV and IR detectors)
- model 20/20 LBC - μ P technology - type UV/IR (pyroelectric, combination of UV and IR detectors)
- model 20/20 I - μ P technology - triple IR detector - 780002 (pyroelectric, sensitive to IR radiation)

These detectors are equipped with various types of terminal block (see table below).

Model	20/20 U	20/20 UC	20/20 UB	20/20 LC	20/20 UNC	20/20 LBC	20/20 I
Type of terminal block	B	C	A	C	C	C	A

- Resistance of cable / unit
 - In the case of local 24 V DC power supply : 8.5 ohms maximum per wire, i.e. 17 ohms in loop
 - In the case of power supply via the MX48 unit : 3 ohms maximum per wire, i.e. 6 ohms* in loop

* 4 ohms for detector 20/20 I (IR3)

- Connection on MX52 unit (ONE detector per measuring channel ONLY):
 - detector equipped with a terminal block of type A: see Fig. 13
 - detector equipped with a terminal block of type B: see Fig. 14
 - detector equipped with a terminal block of type C: see Fig. 15

Example of the utilization of the 4-20 mA signal from flame detectors equipped with connectors of type A or C: see Fig. 16.

Example of the utilization of detectors equipped with connectors of either type A or type B and with auxiliary power supply. The auxiliary power supply must be able to supply power to the number of detectors planned in the measuring loop (see Fig. 17).

REMARK

In the case of this application, the maximum of 3 flame detectors can be connected in the measuring loop.

Example of the utilization of IR3 or UV/IR detectors equipped with connectors of type A with a local junction box and galvanic insulation (see Fig. 18).

1.3.6. CO2 detector of type “Ventostat VT”

- Connection on MX52 unit: see Fig. 20.
- Resistance of detector/unit power cable: 12 ohms maximum per wire, i.e. 24 ohms in loop.
- 4-20 mA output: maximum load = 280 ohms (whole loop)

1.3.7. Specific case of CTX100 / COX 100 intrinsic safety detectors

Two types of intrinsic safety barrier can be used: Z787 / EX and MTL787S+.

PRECAUTIONS

Before connecting the barrier to the unit, check that the voltage is < 25 V DC.

- A short circuit in the electrical connections will result in destruction of the barrier.
- Perform wiring in the DE-ENERGIZED state.
- The electrical link between the MX48 unit and the clipper is made using a screened cable with two active conductors with a maximum resistance of 12 ohms each.

REMARK

In classified areas, the installation must comply with the standards in force.

- Connections on MX52 unit: see Fig. 21.

IMPORTANT

All intrinsic safety installations must be APPROVED as a whole assembly by an approved organization (DRIRE, etc.).

OLDHAM “INTRINSIC SAFETY” BARRIERS

Type of IS barrier	Reference	Specific features	OLDHAM box reference	
Z787 / EX	6184703	To be fitted on DIN RAIL		
MTL787S+	6797100	To be fitted in an approved box: MANDATORY	For 2 clippers	6797192
			For 5 clippers	6797547
			For 12 clippers	6797101

1.3.8. Other detectors with standardized current output

Any detector (with 2 wires or 3 wires) that can be supplied with power between 19 V DC and 32 V DC and that supplies a standardized current (signal) of between 4 and 20 mA can be connected to the MX52 unit.

The connection requirements are identical to those for the corresponding OLDHAM detectors (see Fig. 22).

1.3.9. Parking application

CTX50 "Co parking" toxic gas detectors can be fitted in parallel when a mean gas concentration is to be obtained. The detectors must, imperatively, be located in the same area. In this case, a maximum of five detectors can be connected (see Fig. 23).

1.4. Connecting the unit to external devices

1.4.1. Slaving controls

The 16 measuring channels of the MX52 unit are each equipped with two relays which can be used to control external devices: sirens, solenoid valves, extractors, telephone calls, etc..

For each measuring channel, the relays are distributed in the following manner (see Fig. 7):

- a relay associated with the triggering of alarm 1,
- a relay associated with the triggering of alarm 2,
- use of open or closed contacts selected with a jumper (see Fig. 7),
- use of positive or negative safety selected by programming (see the CHANNEL programming menu),
- contact outputs on the back of the measuring board (see Fig. 12).

- An example of connection is given in Fig. 24:
 - a siren connected to relay AL1 will be actuated as soon as alarm 1 is triggered,
 - a solenoid valve connected to relay AL2 will be actuated as soon as alarm 2 is triggered.

For all channels:

- A common relay associated with the triggering of alarm 3 for the 16 channels.

By programming, this common relay can also be used for the remote transmission of the audio warning signal. (This relay will then be associated with all the unit's alarms). The 3 contacts are available back to power supply module (fig 8).
- A **fault** relay associated with the triggering of channel faults (detector failures, electrical connections, excessively negative zero, etc.). This relay will always be in positive safety mode (see Fig. 5). The use of open or closed contacts is selected by programming on common board.
- Common relay contact outputs on the back of the power module: Fig. 8.

REMARK

Owing to the breaking capacity of the MX52 unit's relays which is limited to 2 A / 250 V AC or 30 V DC, external intermediate relays must be used if the devices to be controlled require high power levels.

1.4.2. 4-20 mA current outputs (Fig. 12)

For each measuring channel, the MX52 unit is equipped with a 4-20 mA output that can be used to retransmit measurements to a recorder or an external PLC. The maximum resistance in loop mode is 600 ohms. The earth connections for the 4-20 mA outputs are common and the unit. The 4-20 mA lines are not galvanically insulated one from the other. The current output varies according to the measurement and has several states, as follows:

- On starting up the unit: $I < 1$ mA
- With FAULT: $I < 1$ mA
- In MAINTENANCE mode: $I = 2$ mA
- ZERO MEASUREMENT: $I = 4$ mA
- Full scale: $I = 20$ mA
- Out of range or "in doubt": $I > 23.2$ mA

An example of the connection of a multi-channel recorder is given in Fig. 25.

1.4.3. RS 232 and RS 485 outputs

RS232 OUTPUT

A computer can be connected on a female sub.D/DB9 type connector located on the back of the micro board (fig6 repA). The MX52 programming, from outside, will be possible thanks to this connection.

RS 232 OUTPUT USING

- Remove the DB9 connector (pmug with an internal strap)
- Connect a link cable ref.6315831 which will link the monitor to the computer on the MX52 available female connector DB9 (repA Fig6)

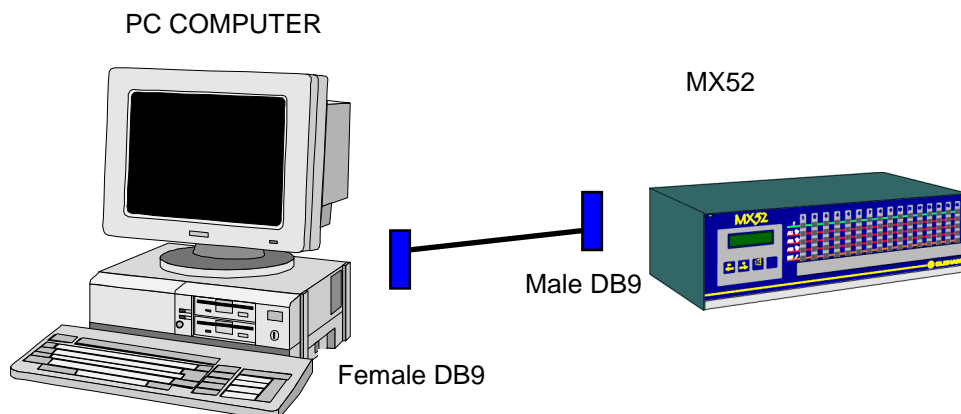

- when the using is stopped : no connect the cable and put the male DB9 "plug" again.

RS 485 OUTPUT (PINABLE ON FIG 29)

Several MX52 units can be linked to a single computer, which is the "master" of the network. In this case, a "SLAVE NUMBER" (by programming/unit) is assigned to each MX52 unit.

This RS 485 output can be galvanically insulated as an option.

1st case : no galvanic insulation

- no mounted insulation component
- 2 polarization electrical resistances are programmed and welded

2nd case : with galvanic insulation

- mounted and welded insulation component
- no programmed polarization electrical resistance for "plus" (+ 5V)
 - a) with RS 485 shielded
 - no programmed polarization resistor for "moins" (GND)
 - b) without RS485 shielded
 - programmed polarization resistor for "moins" (GND)

End loop resistor

It is located on the MX52 micro board and must be programmed with the last MX52 unit of the loop (by pins) with a 120 Ohms value.

The MX52 stored data are some instantaneous values
The RS485 output is a half duplex type.

RS 485 OUTPUT USING

- No change the sub D/DB9 "plug" connector
- Connect the screwed connector terminals 3,4 and 5, located on the back of the MX52 unit (repB Fig6). See connection details fig 29.
- Owing to mounted wires or not (following the mounting and the equipment linked or not on the earth...).

IMPORTANT

All details regarding the RS 485 complete description (Modbus / Jbus format, structures, adresses aso...) are developed in a leaflet ref. D 813 577.

CAUTION

A computer must be used in order to printout the data stored by the MX52 unit.

1.4.4. Remote acknowledgement

It is possible to allow remote acknowledgement by connecting on connector 5 plugs, on the back or the micro board : see fig 6 item B.

2. SWITCHING ON

2.1. CHECKING THE INSTALLATION

It is accepted as a minimum that all connections have been made and that the complete installation complies with standards currently in force.

ATTENTION

The compliance of the complete electrical safety system is not OLDHAM's responsibility

The MX52 facility can be made live using trip switches* which are provided for this purpose and which protect the mains supply.

* the trip switches will be selected on the basis of the consumption figures provided by the manufacturer and of the length of the electrical cables.

2.2. SWITCHING ON THE FACILITY

ATTENTION

The procedures and adjustments described in these paragraphs are reserved strictly for authorized persons since they may jeopardize detection safety.

The MX52 facility is switched on by :

- pivoting the front panel
- pressing the ON / OFF button located at the bottom left of the FRONT circuit : see Fig.4 and fig.26 (ref A)
- the following then appears on the display...for example

MX52	V2.0
------	------

The facility then goes into SETUP for 1 minute. Hence, for those channels which are in service all the alarms are disabled and the output currents are 1 mA. The facility also performs a self-test* of its buzzer and of all the LEDs. After the minute has elapsed the channels in service are set into normal operation and the associated alarms and relays become effective.

*The user can do a "manual self-test" by pressing the TEST key at any time (Fig.26)

This self-test lasts 20 seconds and the following may appear alternately on the display, for example :

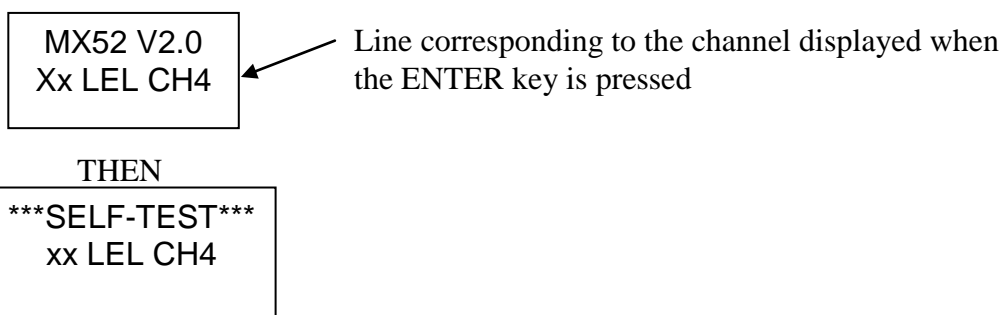

The user can stop the self-test cycle early by pressing the CLEAR key.

2.3. OPERATING MODES

2.3.1. Buzzer

During normal operation and whenever there is a fault or an alarm, the buzzer is triggered. The buzzer is stopped by pressing the CLEAR key or by clearing remotely. The buzzer emits a continuous or discontinuous sound (depending on how the facility is programmed) should an alarm threshold be exceeded.

2.3.2. Light-emitting diodes (LEDs) (fig26)

Each channel has 5 LEDs (which are visible and labelled on the FRONT panel) :

LED	UNLIT	PERMANENTLY LIT	FLASHING
GREEN	Channel not in service	Channel in service	
1 st red	AL 1 not triggered	AL 1 threshold exceeded (with automatic cancellation)	AL 1 threshold exceeded (with manual cancellation) and not cleared
2 nd red	AL 2 not triggered	AL2 threshold exceeded (with automatic cancellation)	AL 2 threshold exceeded (with manual cancellation) and not cleared
3 rd red	AL 3 not triggered	AL 3 threshold exceeded (with automatic cancellation)	
Yellow	No fault	Channel faulty	- channel being calibrated or programmed - Sensor being calibrated

2.3.3. Alarm thresholds

Each of the 3 alarm thresholds can be programmed independently for each channel (see “Channel programming” menu).

During normal operation a gas alarm is triggered only after a programmed lag, so as to avoid untimely alarms.

The alarm thresholds can be dealt with in the following ways :

- during a normal cycle with manual cancellation
- during a normal cycle with automatic cancellation
- during a parking cycle

The alarm thresholds will be selected on the basis of the gases detected and of the corresponding standards in force.

Special case : A channel connected to a fire sensor.

- the 100-division scale **MUST** be selected
- the alarm threshold **MUST** have 60 divisions

(Because of the end-of-loop resistance of 2.7 k Ω , the fire sensor will deliver 4 mA when there is no fire and 20 mA should a fire be detected).

2.3.4. The measurement facility

One minute after switching on and if no test action is performed on the keypad, the facility scans all the live channels in succession and displays the values measured.

Examples of the display

Channel 1 xx LEL CH4

OR

Channel 2 xxx ppm CO

- Each channel is interrogated for 10 seconds
- The user can interrogate a channel manually by selecting this channel with the + and – keys for manual display lasting 1 min.
- The user can return to normal cyclic scanning, during this minute, by pressing the + and – keys simultaneously and the display then indicates (alternately) and 3 times in succession.

For example :

Channel 5 xxx ppm CO

THEN

Normal scan xxx ppm CO

3. USE

3.1. LIST AND FUNCTION OF THE VARIOUS “USER” ELEMENTS FOR PROGRAMMING AND CALIBRATING THE FACILITY

3.1.1. The keypad (see Fig.26 and 4)

Equipped with 4 touch keys which can be accessed without opening and pivoting the FRONT panel for maintenance.

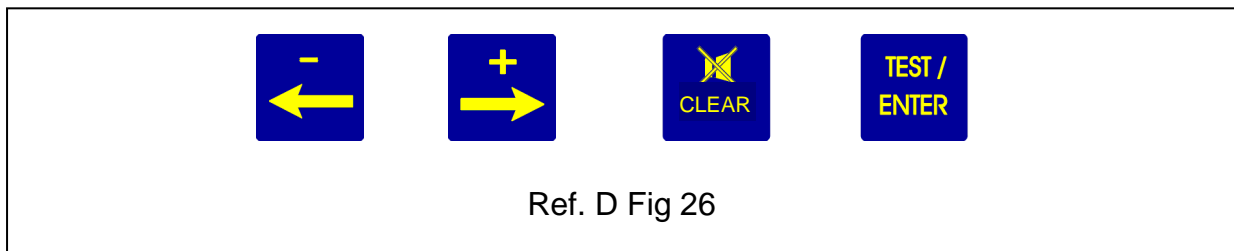

NORMAL MODE

- Manual display of the previous channel
- Combined with the “PLUS” key for reinitiating the automatic channel display cycle

MAINTENANCE MODE

- Manual display of the previous menu
- Decreasing the value, threshold, etc.
- Displaying the previous selection (ON / OFF, etc.)
- NO



NORMAL MODE

- Manual display of the next channel
- Combined with the “MINUS” key to reinitiate the automatic channel display cycle.

MAINTENANCE MODE

- Manual display of the next menu
- Increasing the value, threshold, etc.
- Display the next selection (ON / OFF, etc.)
- YES



- “Audible and visual” or “audible” cancellation of an alarm.
- To exit a current menu



- Initiate a self-test manually
- VALIDATION

3.1.2. *The maintenance keys*

- PROGRAMMING key (réf. B Fig. 26) can be accessed after opening and pivoting the front panel.
 - Combined with the “-“ key to go back through a menu.
 - Used for exiting the normal display mode and for accessing the various menus (see the overview of the various menus)
 - used to scroll through a menu
- CALIBRATION key (Ref. C Fig.26) can be accessed after opening and pivoting the front panel.
 - places a channel into CALIBRATION mode
 - Used to exit this same mode

4. Scrapping of MX52

Concerning the conservation, of the protection and the improvement of the quality of the environment, as well as for the protection of the health of the persons and the careful and rational use of natural resources, MX52 has to be the object of a selective collection for the electronic equipments and cannot be scrapped with the normal domestic waste. The user thus has the obligation to separate the MX52 of the other waste so as to guarantee that it is recycled in a sure way at the environmental level. For more details of the existing sites of collection, contact the local administration or the distributor of this product.

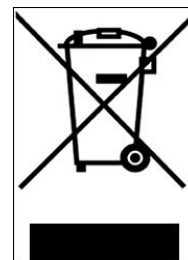

5. Special Specifications for use in Potentially Explosive Atmospheres in accordance with European Directive ATEX 94/9/EC.

The MX52 central unit designed to measure explosive gasses and oxygen complies with the requirements of European Directive ATEX 94/9/EC on potentially explosive atmospheres.

As a result of its metrological performance, as tested by the research and testing organisation INERIS, the MX52 device, is classified as a safety device when used with OLDHAM CEX300 and OLC/OLCT 20, 40, 50 and 60 series detectors. The device may therefore contribute to limiting the risk of explosion as a consequence of the data it supplies to external units.

The information contained in the following paragraphs should be adopted and complied with by the person responsible for the site on which the equipment is installed. Please refer to the provisions of European Directive ATEX 1999/92/EC on improving health and safety conditions for workers exposed to potentially explosive atmospheres.

5.1. SPECIFICATIONS FOR MECHANICAL AND ELECTRICAL INSTALLATION IN CLASSIFIED AREAS.

Installation will comply with all applicable standards, and particularly with EN 60079-14, EN 60079-17 and EN 50281-1-2.

The MX52 device must not be subject to intense mechanical vibration and must be installed in a safe area away from potentially explosive atmospheres.

It is essential to refer to the user and installation manuals for the gas detectors referred to above, particularly the paragraph entitled ‘Special Specifications for use in Potentially Explosive Atmospheres in Accordance with European Directive ATEX 94/9/EC’

Where intrinsic safety installations are concerned, it should be borne in mind that the person responsible for IS installation (the “System Designer”) must draw up a system document demonstrating that every aspect of the Power Cable Detector system complies with intrinsic safety. Please refer to EN 50039 for group II and EN 50394-1 for group I when drafting this document.

5.2. METROLOGICAL SPECIFICATIONS

The device complies with the following European standards:

With explosive gas detectors:

- European standards EN 50054 and EN 50057 for Methane (calibration gas), Propane and Hydrogen (gasses following response curves) where the device is used with CEX300 and OLC/OLCT 20, 40, 50 and 60 series gas detectors. Where the device is used with other types of sensor producing an output measurement current of 4/20 mA, these must comply with paragraph 1.5 of Appendix II of the ATEX 94/9/EC Directive and be compatible with their characteristics (cf. device transfer curve).

- European Standard EN 50271

Oxygen detectors:

- European Standard EN 50104 where the device is used with OLCT 20, 40, 50 and 60 gas detectors. Where the device is used with other types of sensor producing an output measurement current of 4/20 mA, they must comply with paragraph 1.5 of Appendix II of the ATEX 94/9/EC Directive and be compatible with their characteristics (cf. device transfer curve).
- European Standard EN 50271

5.3. CONNECTING DETECTORS OTHER THAN OLDHAM DETECTORS TO THE MX52 DEVICE

As previously explained, users wishing to connect detectors other than those manufactured by OLDHAM, must ensure their compatibility with the device in order that the resulting combination may be considered as a safety device.

5.3.1. Device transfer curves in 0% to 100% LEL configuration

The following curve shows the response of the device in terms of value measured, and fault processing as a function of the input current value supplied by the detector. Where the user connects a brand of detector other than OLDHAM to the MX52 device, he must check carefully that the transfer curve is fully compatible with the device input characteristics, to ensure that the data generated by the detector is correctly interpreted. Equally, the device must supply a suitable power supply voltage, allowing for cable voltage losses.

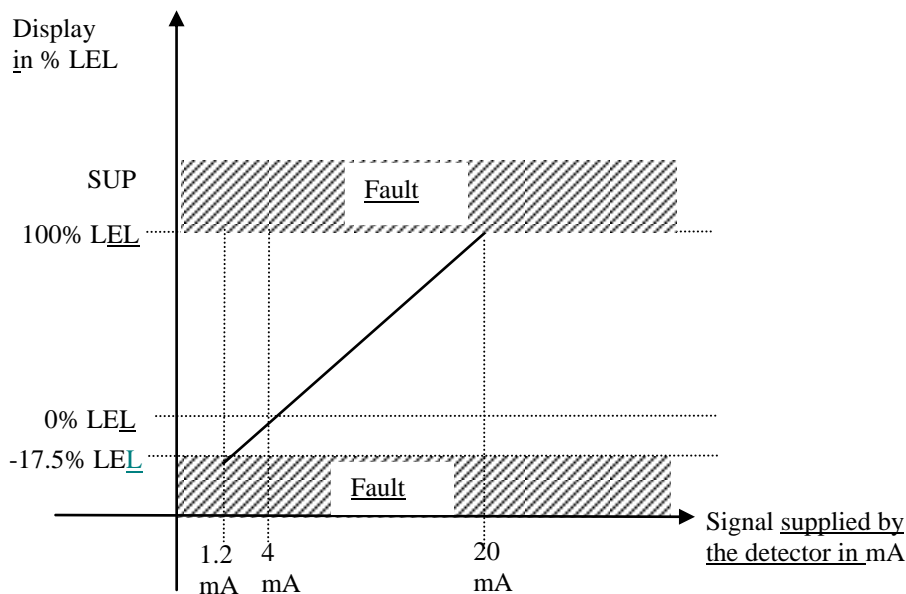

Please note: When the value measured is $\geq 100\%$ LEL, the measuring device memorises the fact that the value has exceeded the scale and the channels switch to alarm and fault mode. Resetting these statuses is a manual operation to be performed by the user, who must follow the safety regulations specific to the site. The reset is checked either by turning the device on and off or by a maintenance inspection.

5.3.2. Device transfer curves in 0% to 30.0% OXYGEN configuration

The following curve shows the response of the device in terms of value measured, and fault processing as a function of the input current value supplied by the detector. Where the user connects a brand of detector other than OLDHAM to the MX52 device, he must check carefully that the transfer curve is fully compatible with the device input characteristics, to ensure that the data generated by the detector is correctly interpreted. Equally, the device must supply a suitable power supply voltage, allowing for cable voltage losses.

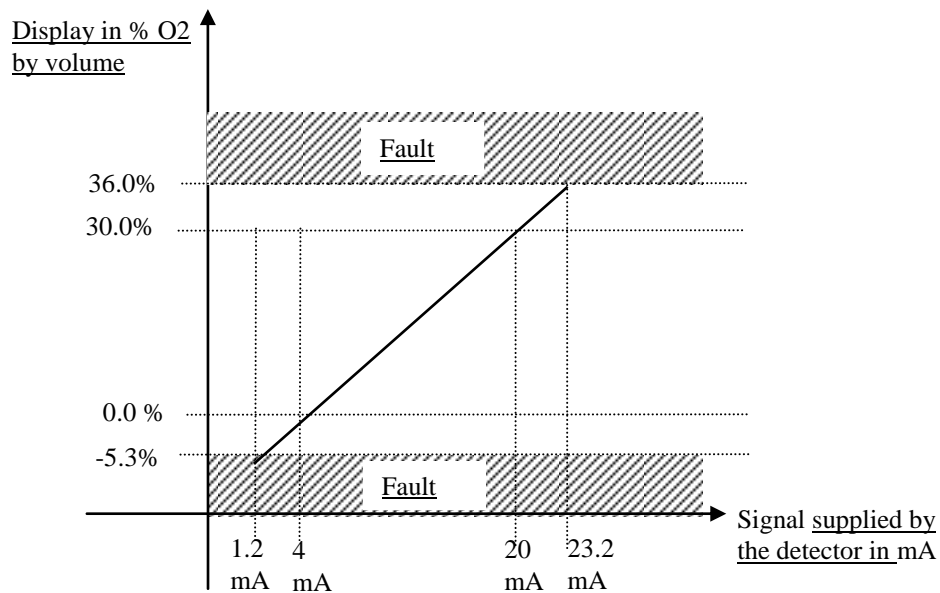

5.3.3. Power supply and load resistance characteristics

Maximum current available between terminals 2 and 3: 350 mA at 21 V.

Maximum no-load voltage between terminals 2 and 3: 30 V

Load resistance (outside the IS barrier) between terminals 1 and 2: 47 ohms

N.B.: This data applies only where detectors other than OLDHAM are used. Where different types are mixed, please contact OLDHAM to establish the feasibility of the combination.

5.4. MARKING

OLDHAM

CE 0080

Ex II 2 (G)

INERIS 04ATEX0064



DECLARATION UE DE CONFORMITE
EU Declaration of Conformity



La société Oldham S.A.S., ZI Est 62000 Arras France, atteste que la
Oldham S.A.S. company, ZI Est 62000 Arras France, declares that the

centrale de mesure MX 52
MX 52 Controller

reliée aux détecteurs de gaz (connected to gas detectors):
CEX300, TBGW-Ex, OLC(T) IR, 20, 40, 50, 60, 100

est conforme aux exigences des Directives Européennes suivantes :
complies with the requirements of the following European Directives:

II Directive Européenne ATEX 2014/34/UE du 26/02/14: Atmosphères Explosives
The European Directive ATEX 2014/34/EU dated from 26/02/14: Explosive Atmospheres

Normes appliquées:
Applied Standards

EN 50054, EN 50057, EN 50104

Performances météorologiques pour la détection des gaz combustibles et de l'oxygène
Performance requirements for combustible gases and oxygen
EN 50271-01 (MX 52 Version == V2.R16)
Appareils de détection de gaz utilisant un logiciel et/ou des technologies numériques
Apparatus for the detection of gases using software and/or digital technologies

Note: L'équipement n'est pas impacté par les modifications exigées de la version harmonisée EN 60979-20-1
The equipment is not impacted by the major changes of EN 60979-20-1

Catégorie (Category):



Attestation CE de Type du matériel:
EC type examination certificate

INERIS 04ATEX0064

Notification Assurance Qualité de Production:
Notification of the Production QA

INERIS 00ATEXQ400

Délivré par l'Organisme notifié numéro 0080
Issued by the Notified Body n°0080

**INERIS, Parc Alata
60550 Verneuil en Halatte France**

II Directive Européenne CEM 2014/30/UE du 26/02/14: Compatibilité Electromagnétique
The European Directive EMC 2014/30/EU dated from 26/02/14: Electromagnetic Compatibility

Normes harmonisées appliquées:
Harmonized applied Standards

EN 50270:06 for type 1&2

CEM-Appareils de détection de gaz
EMC-apparatus for the detection of gases

III Directive Européenne BIE 2014/35/UE du 26/02/14: Basse Tension
The European Directive LVD 2014/35/EU dated from 26/02/14: Low Voltage

Normes harmonisées appliquées:
Harmonized applied Standard

EN 61010-1:10

Règles de sécurité pour appareils électriques de mesure
Safety requirements for electrical equipment for measurement

Arras, le 20/04/2016 (April 20th, 2016)

Michel Spellenacker



Oldham S.A.S.
ZI EST - CS 20417
59027 ARRAS Cedex - FRANCE
www.oldhamgas.com



Global Director of Product Management

UE_ATEX_MX 52_p01 A



**SECURITE FONCTIONELLE (Functional Safety)
DONNEES DE FIABILITE (Reliability Data)**



La Société Oldham S.A.S., ZI Est 62000 Arras France, atteste que la :
(The Company Oldham S.A.S., ZI Est 62000 Arras France, declares that:)

CENTRALE DE MESURE Type MX52

MX52 Gas Detection Controller

est un Système Instrumenté de Sécurité de niveau d'intégrité **SIL 2**
(is a Safety Instrumented System of safety integrity level **SIL 2**)

La déclaration est basée sur une analyse de fiabilité conformément à la notion de composant éprouvé par l'usage telle que décrite dans la norme EN 61511-1 Paragraphe 11.5.4.
(The declaration is based on a reliability analysis in compliance with the concept of component proven in use as described in the standard EN61511-1 Paragraph 11.5.4)

L'analyse de fiabilité a fait de l'objet de l'Attestation INERIS n° 68210-2005 du 19 décembre 2005.
(The reliability analysis is issued from the INERIS Examination n° 68210-2005 dated from December 2005, the 19th)

L'analyse des données de fiabilité a permis de déterminer :
(The reliability data analysis has led to determine :)

Taux de défaillance dangereuse non détectée (undetected dangerous failure rate):	$\lambda_{du} = 0,5 \cdot 10^{-6}/h$
Proportion de défaillance en sécurité (Safe Failure Fraction):	SFF = 93 %

Sous réserve que les relais de la centrale soient paramétrés en sécurité positive (provided the MX52 relays are energized)

Les données ci-dessus répondent aux exigences pour le niveau SIL 2 telles que définies dans les tableaux 4 et 5 de la norme EN61511-1, le mode de fonctionnement considéré pour la centrale étant le mode continu.
(The data above comply with level SIL2 requirements as defined in table 4 and table 5 of EN61511-1 Standard, the operating mode to be considered is the continuous mode)

Exigences pour le SIL 2 – SIL 2 Requirements	
$10^{-5} /h < \lambda_{du} < 10^{-6} /h$	90 % < SFF < 99 %

SIL MX52.ind #

Arras, le 26/09/2015

Michel Spellemaker



Oldham S.A.S.
Z.I. EST - C.S. 20417
62017 ARRAS Cedex - FRANCE
www.oldhamgas.com



Global Director of Product Management

6. Views depicted in the leaflet

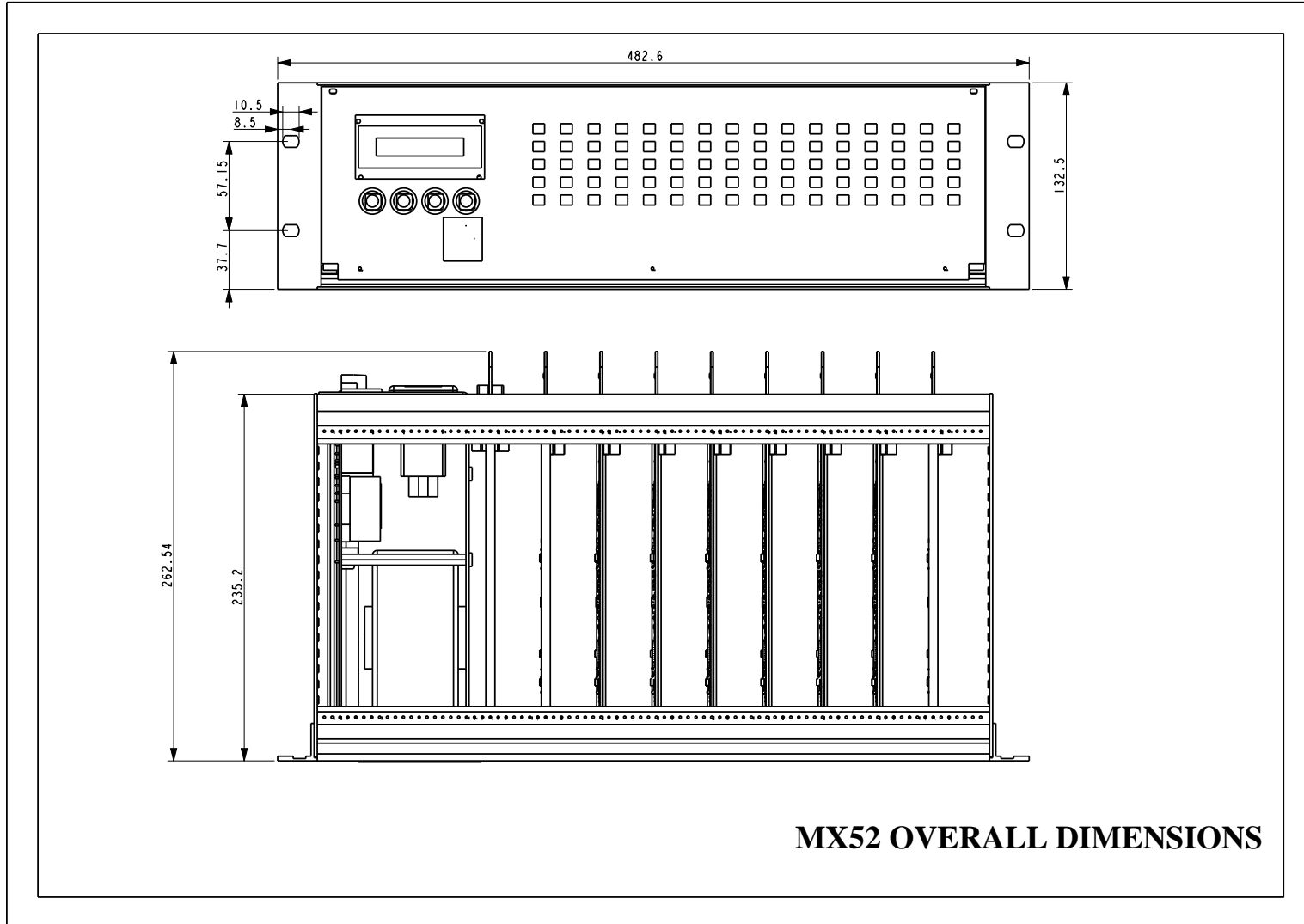

FIGURE 1

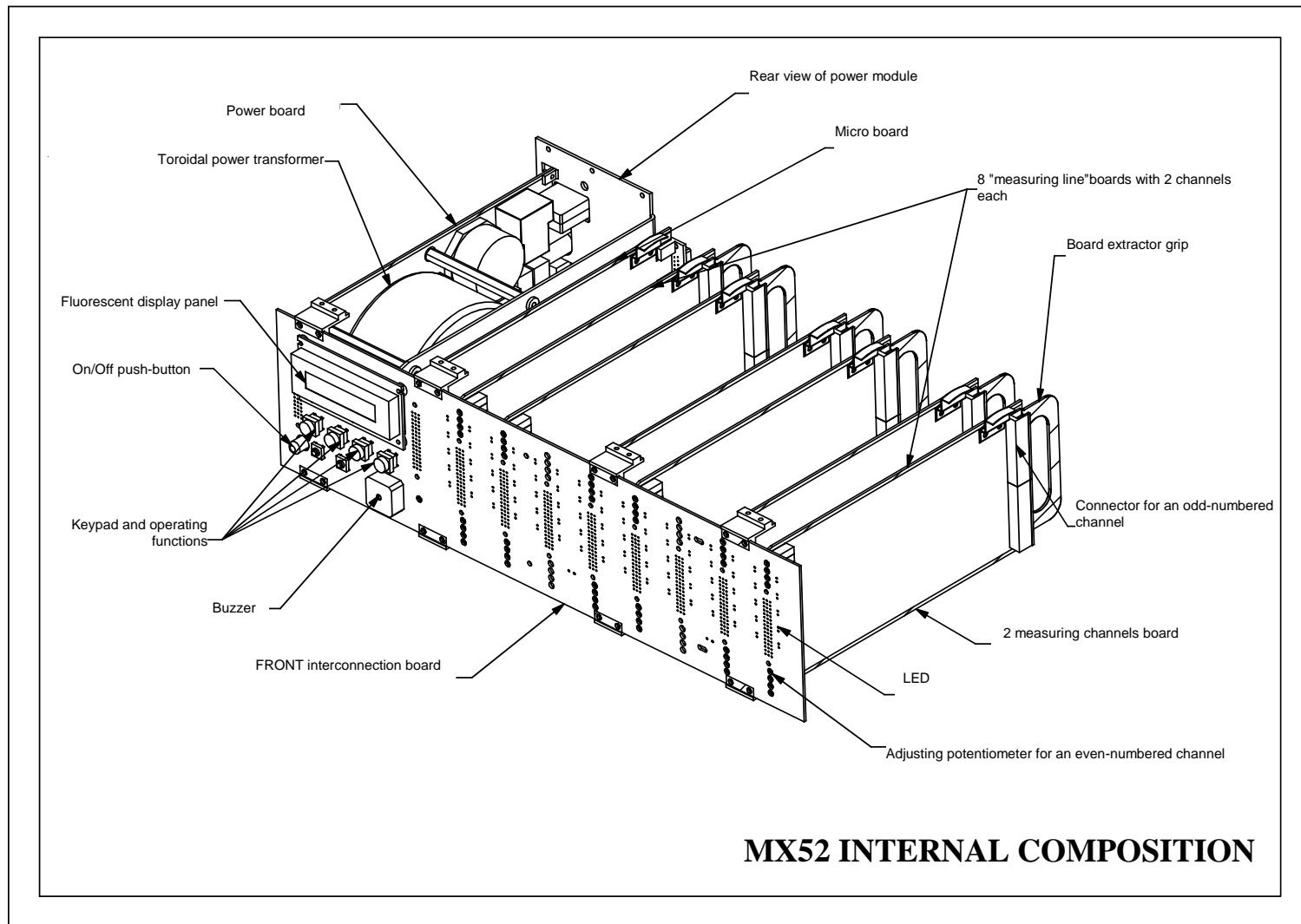

FIGURE 4

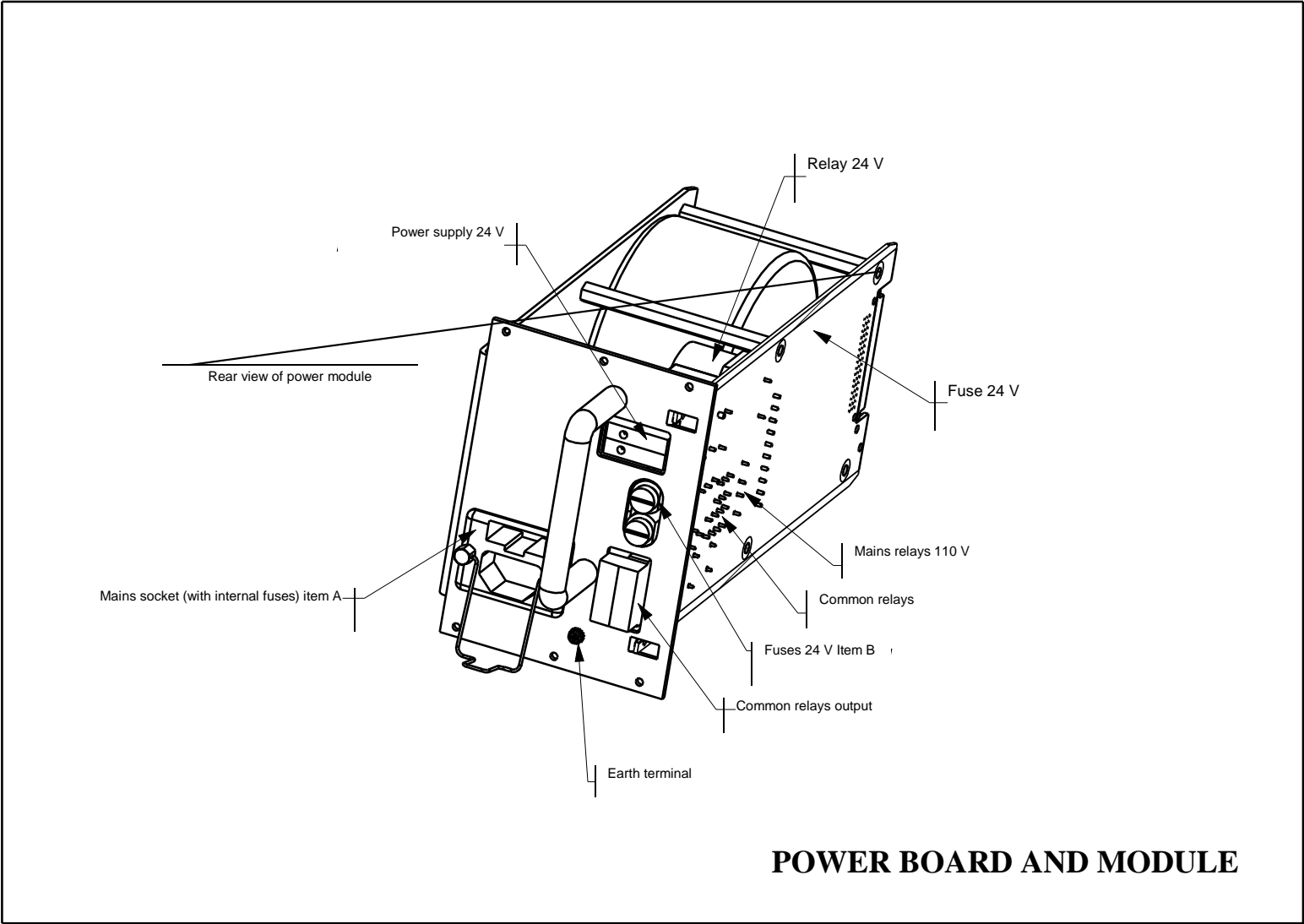
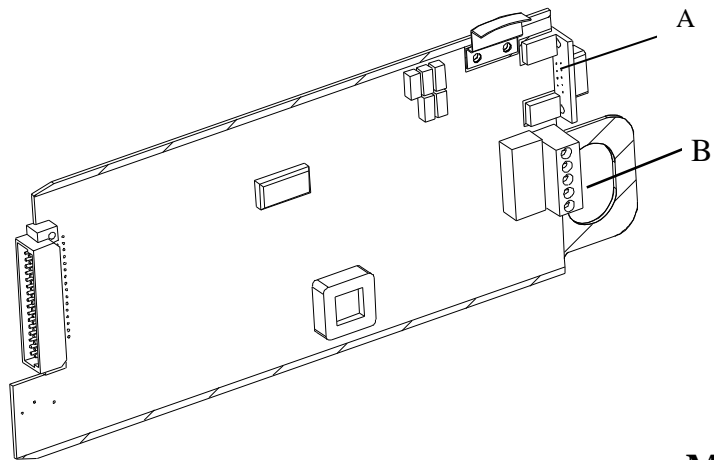
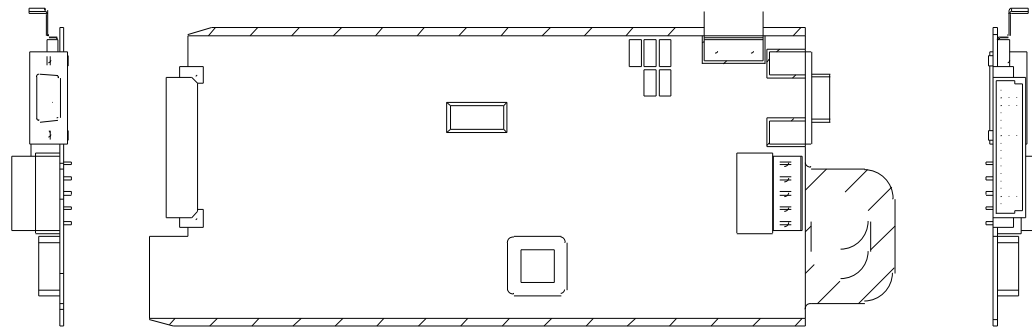

FIGURE 5



MICRO BOARD

FIGURE 6

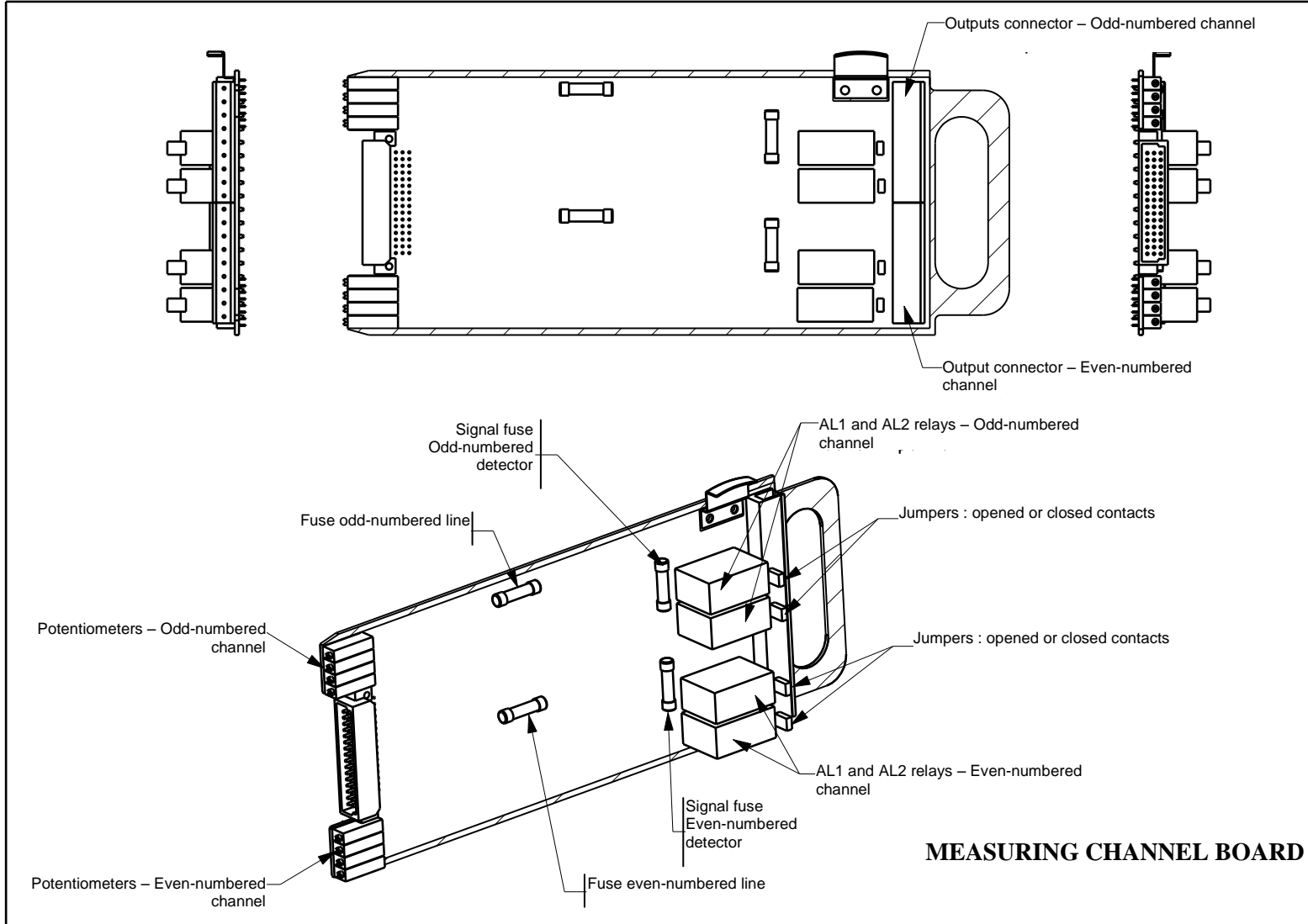

FIGURE 7

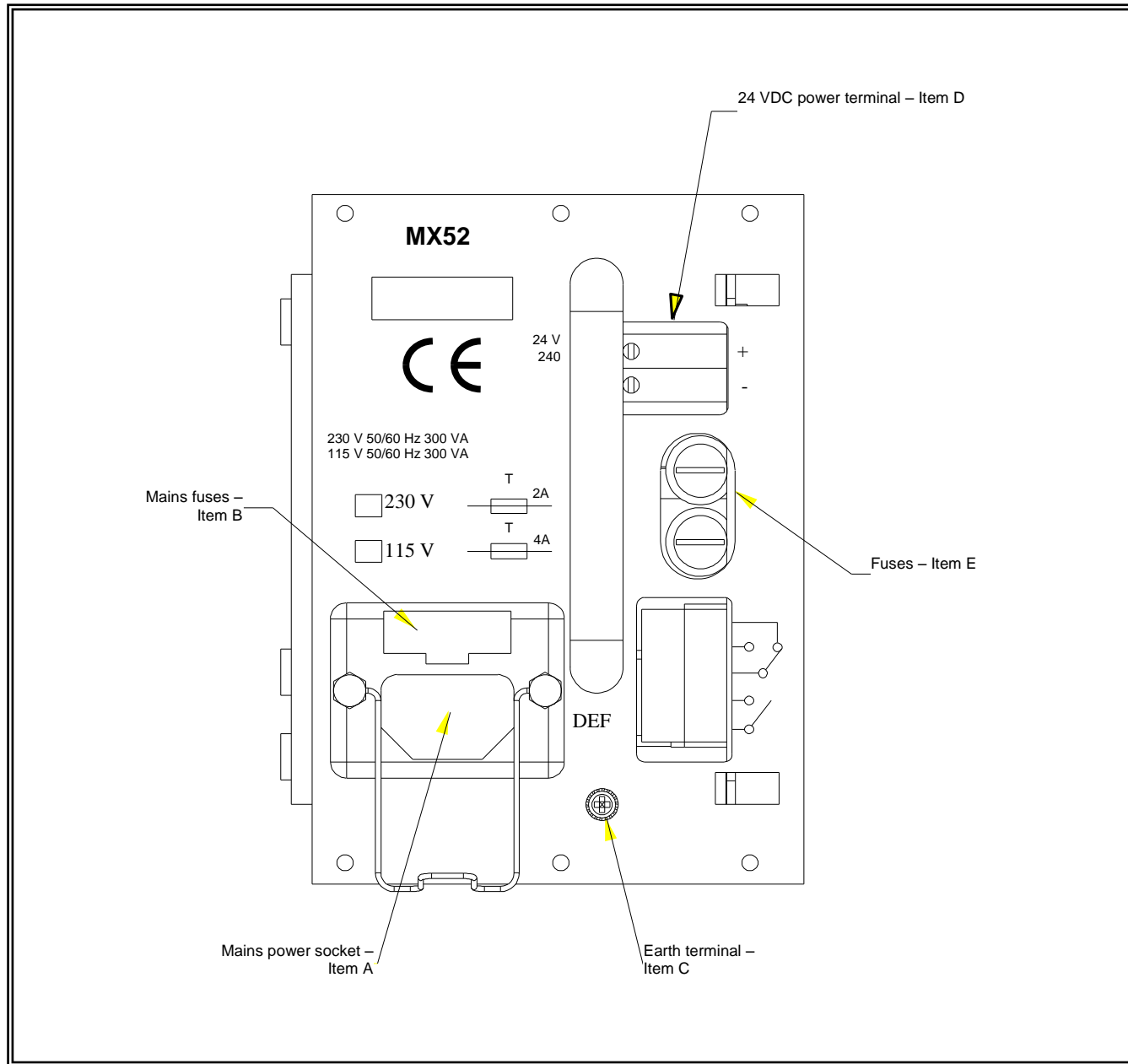

FIGURE 8

REAR VIEW OF POWER MODULE

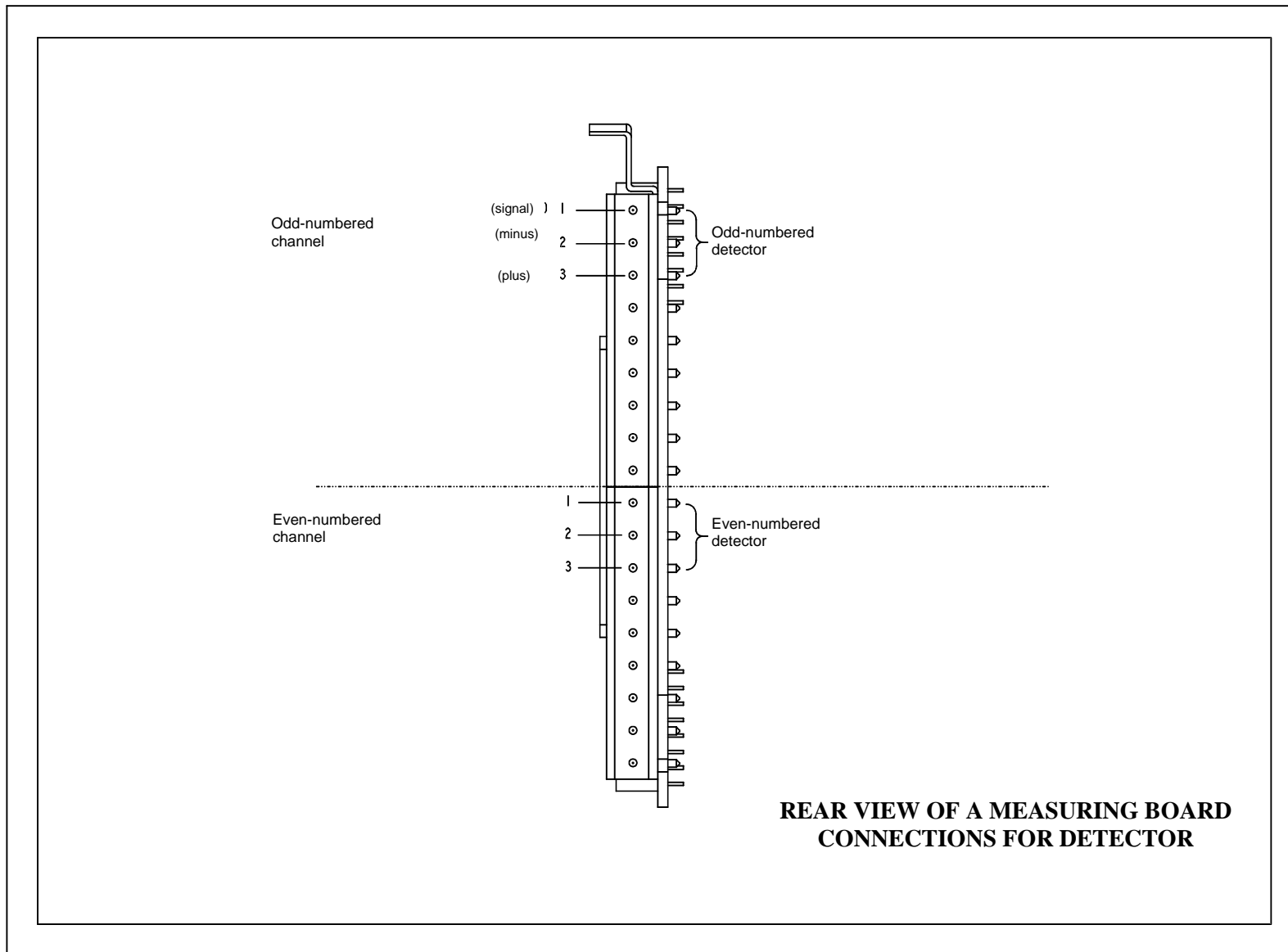

FIGURE 9

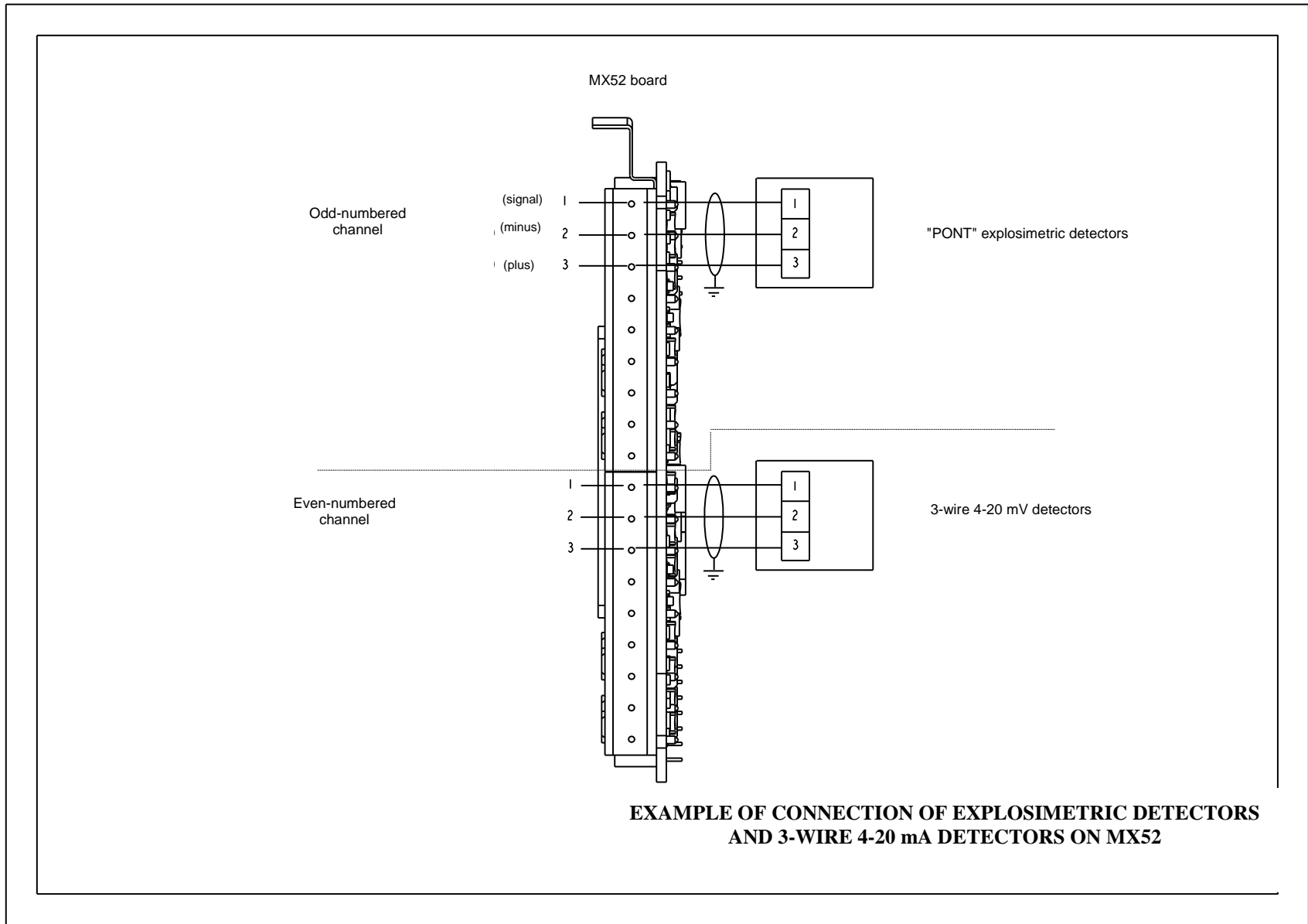

FIGURE 10

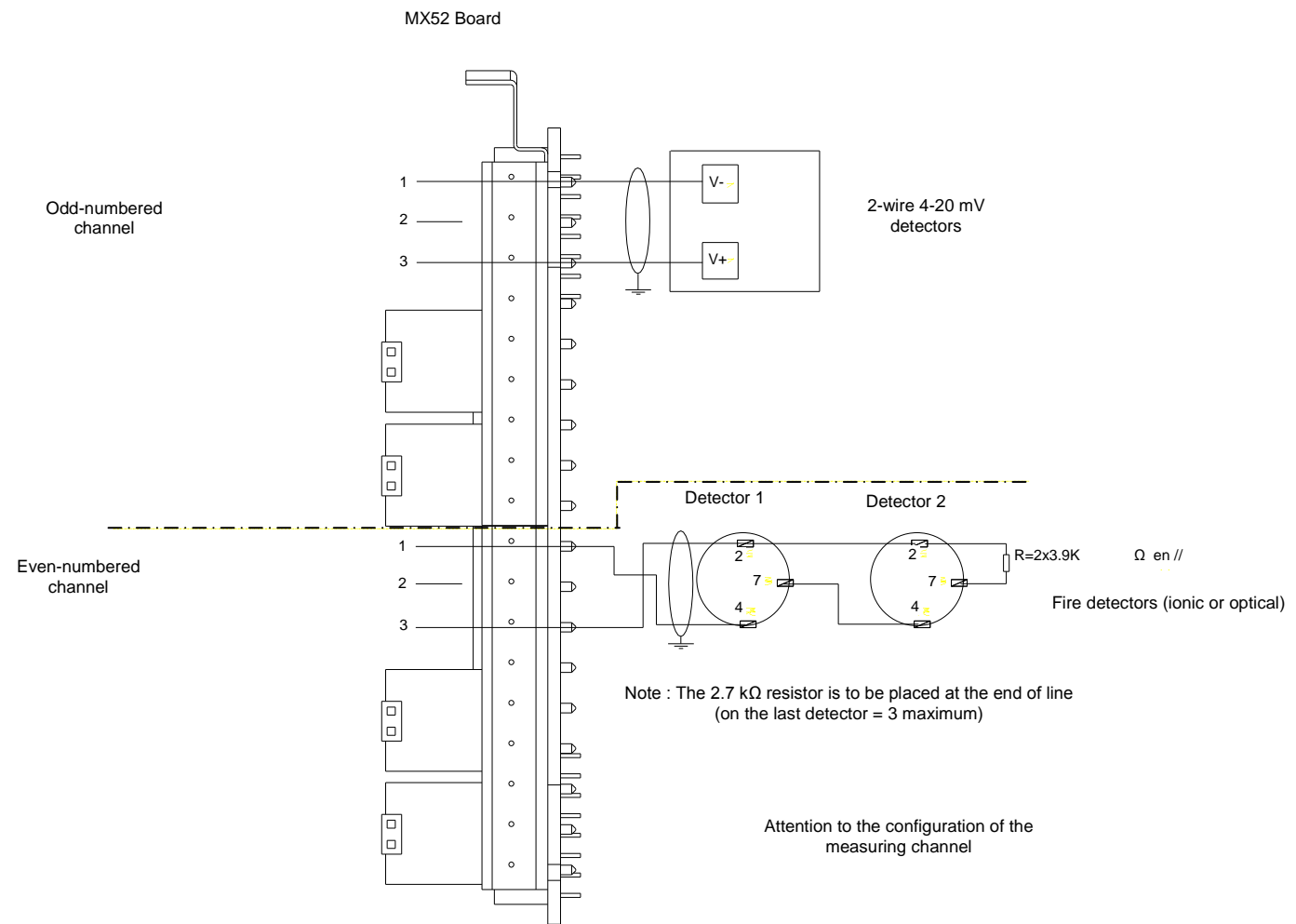

FIGURE 11

EXAMPLES OF CONNECTION OF 2-WIRE 4-20 mA DETECTORS

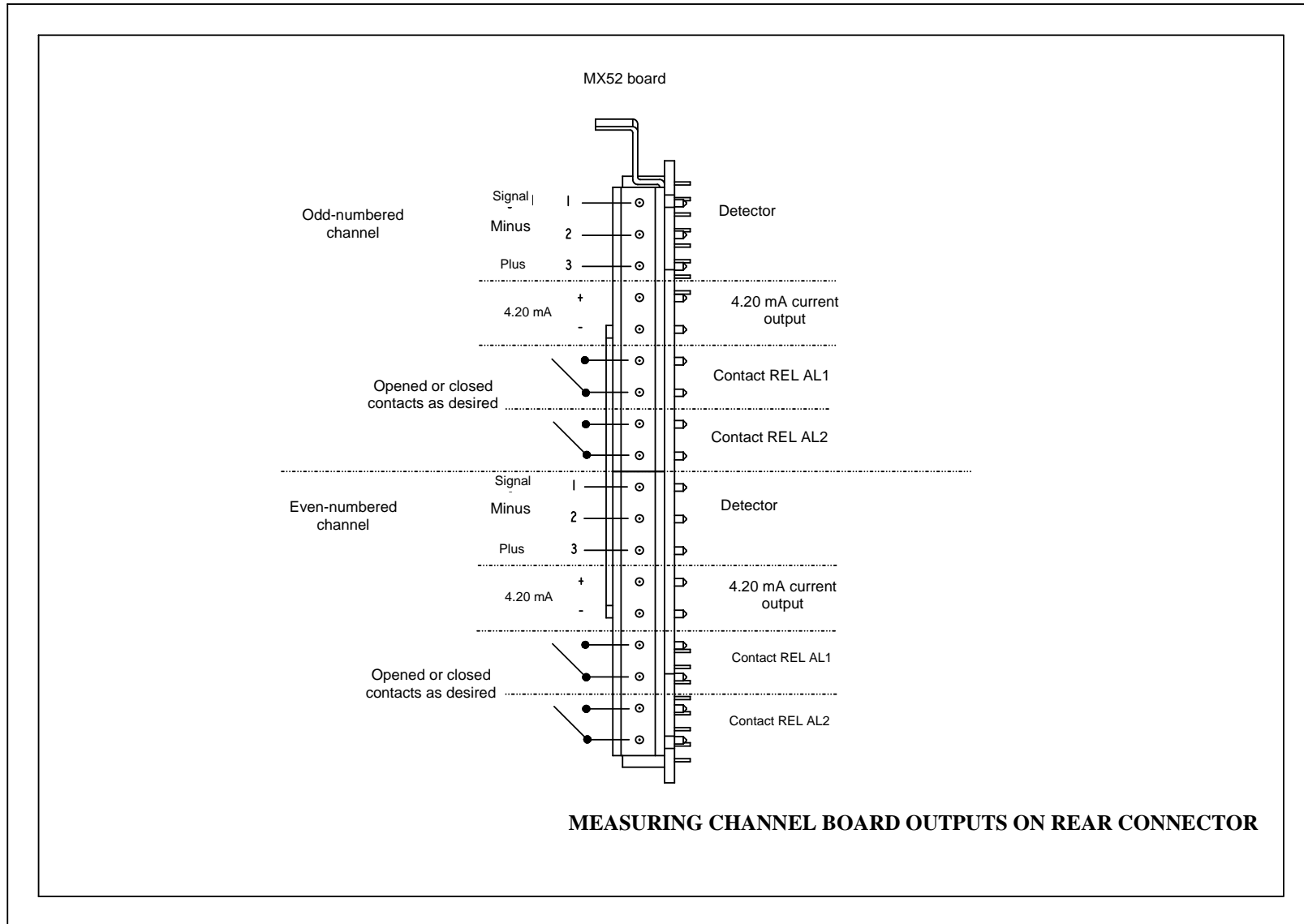
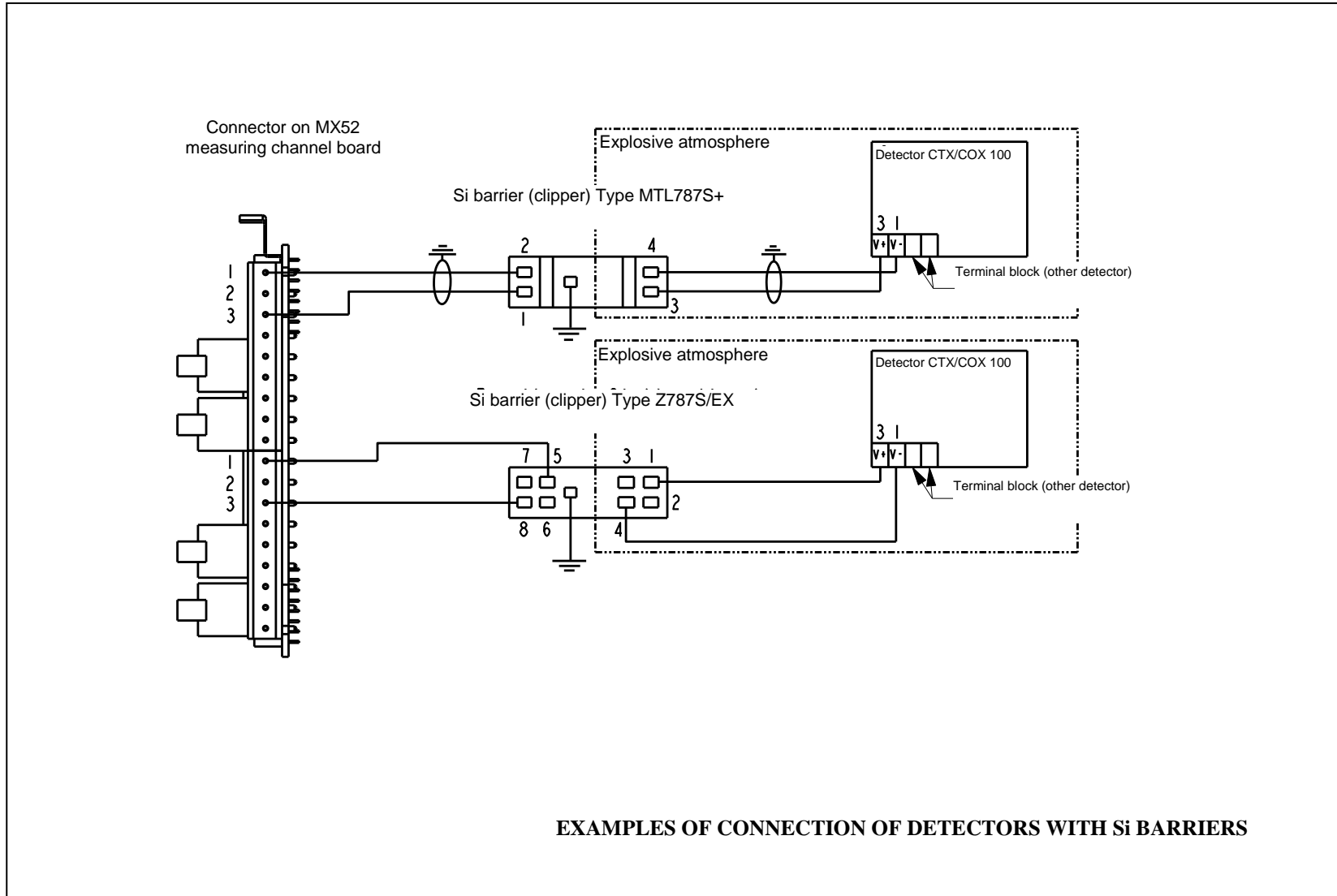
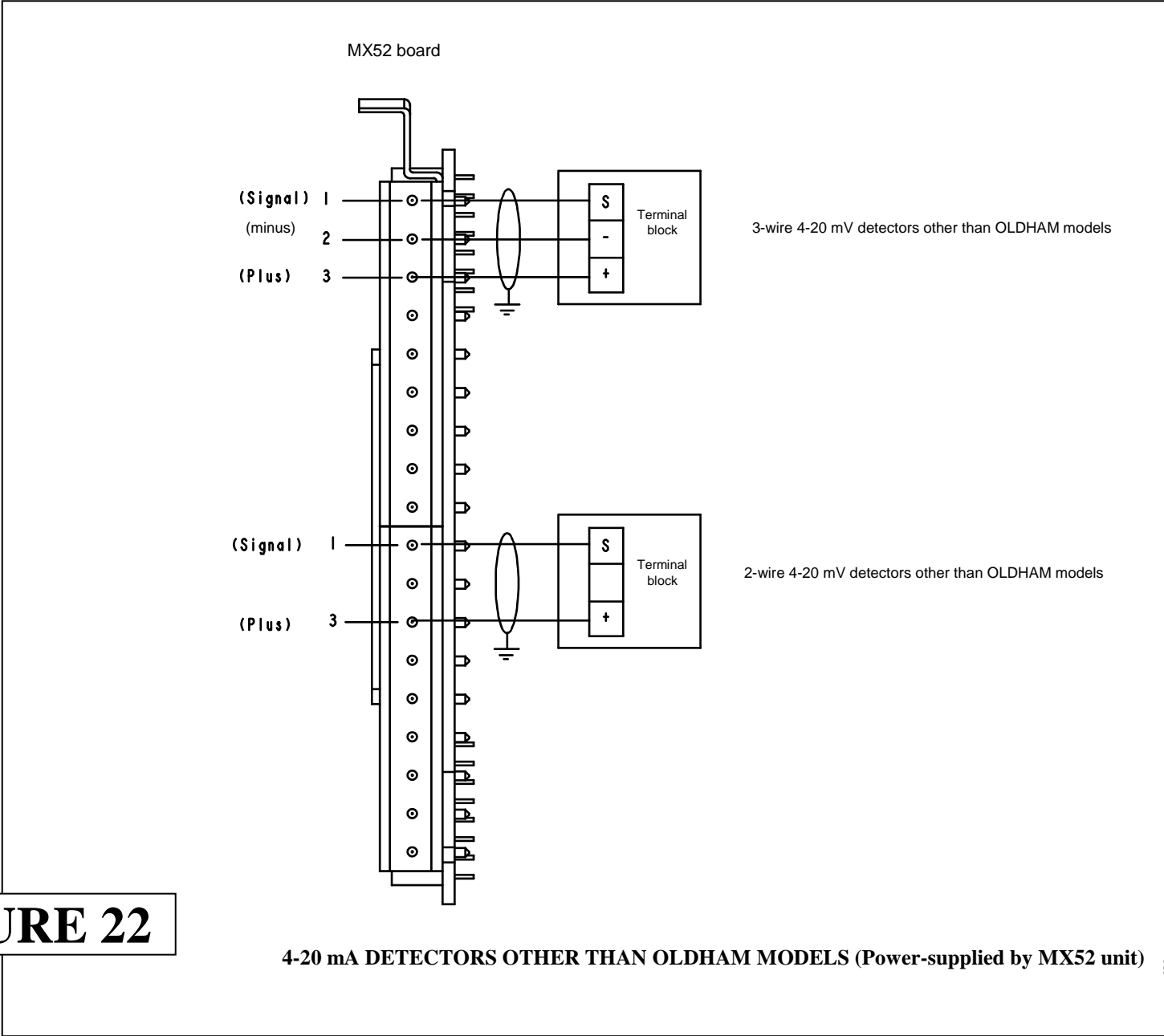

FIGURE 12



EXAMPLES OF CONNECTION OF DETECTORS WITH SI BARRIERS

FIGURE 21



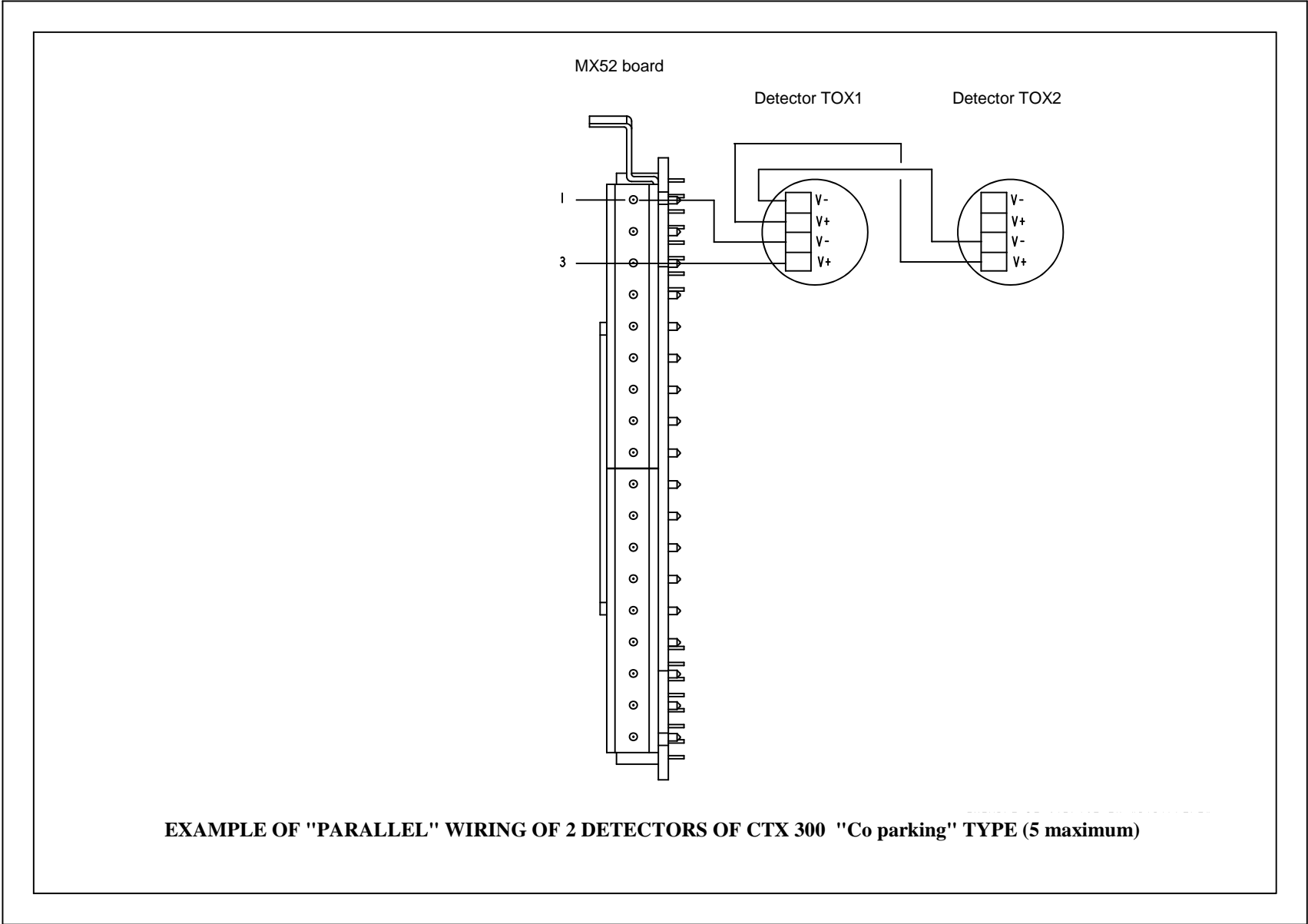

EXAMPLE OF "PARALLEL" WIRING OF 2 DETECTORS OF CTX 300 "Co parking" TYPE (5 maximum)

FIGURE 23

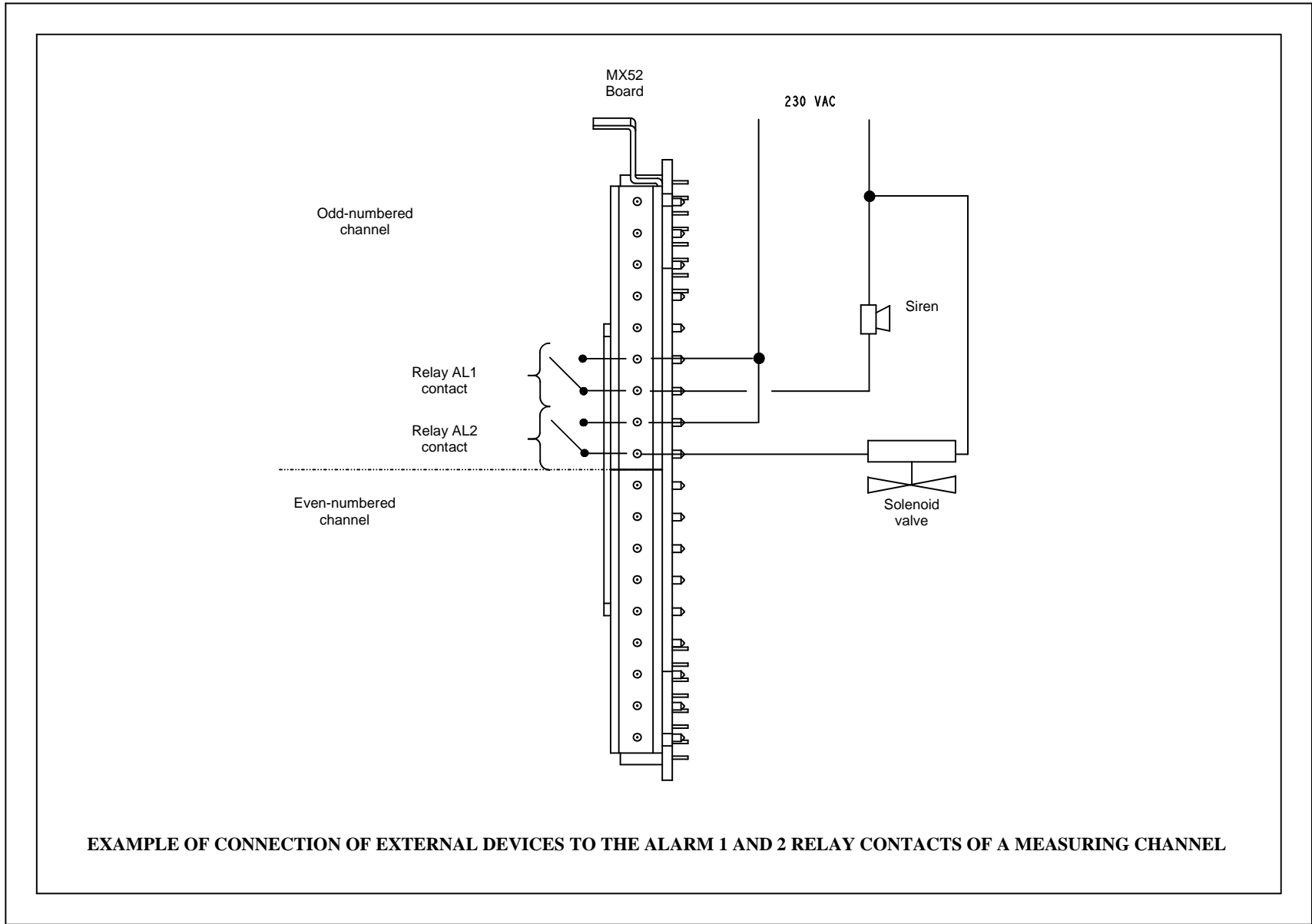
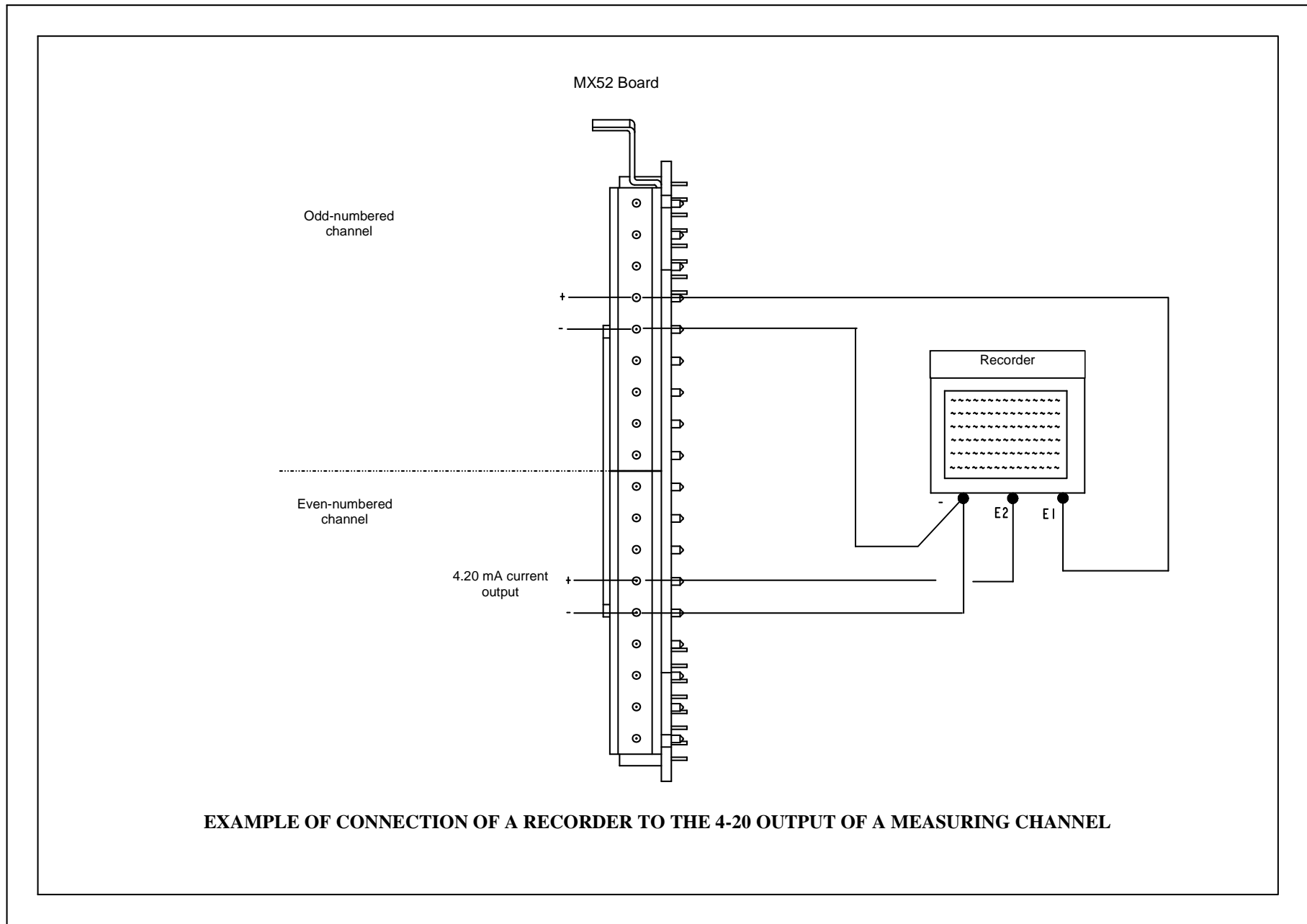

FIGURE 24



EXAMPLE OF CONNECTION OF A RECORDER TO THE 4-20 OUTPUT OF A MEASURING CHANNEL

FIGURE 25

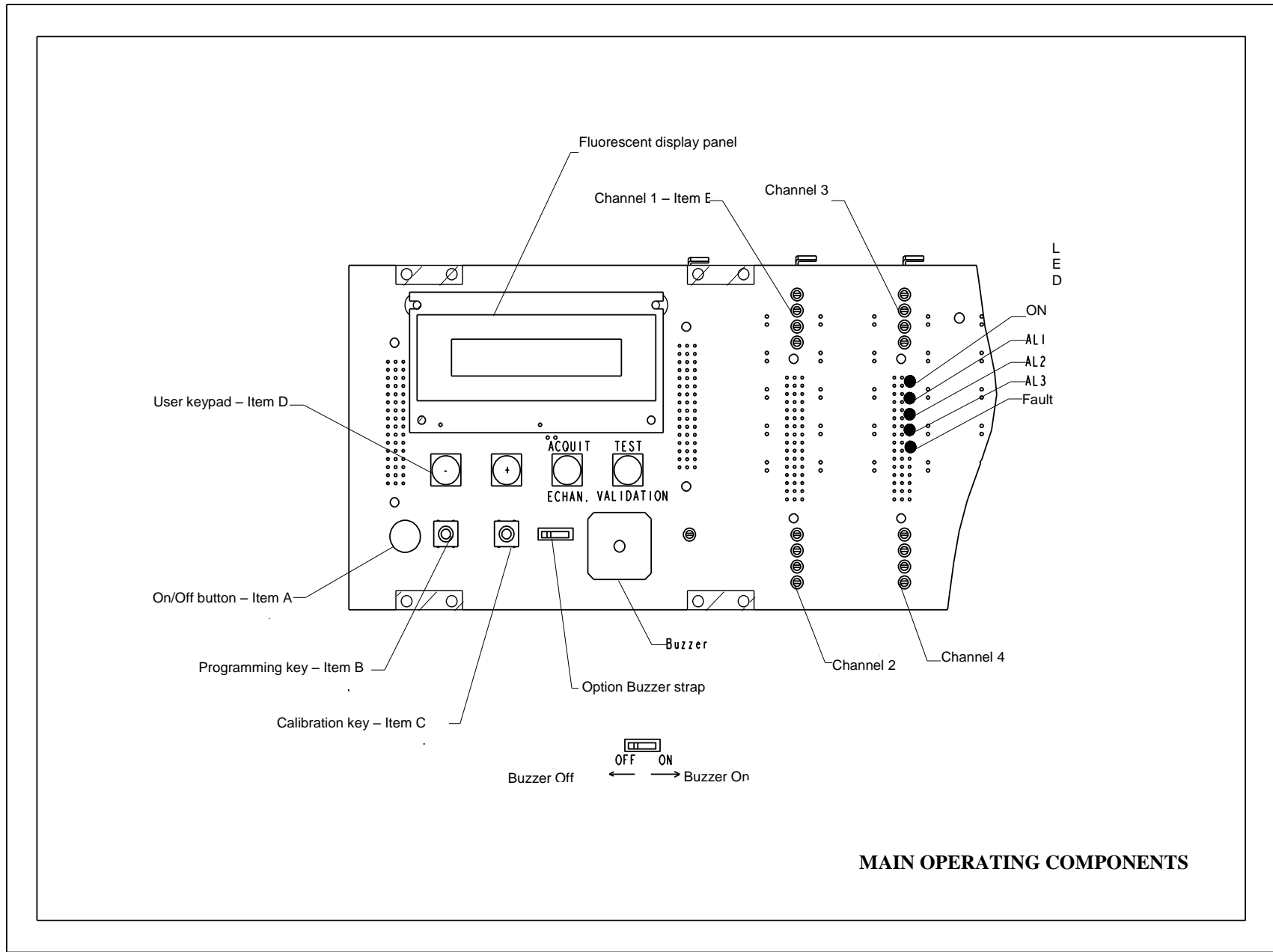

FIGURE 26

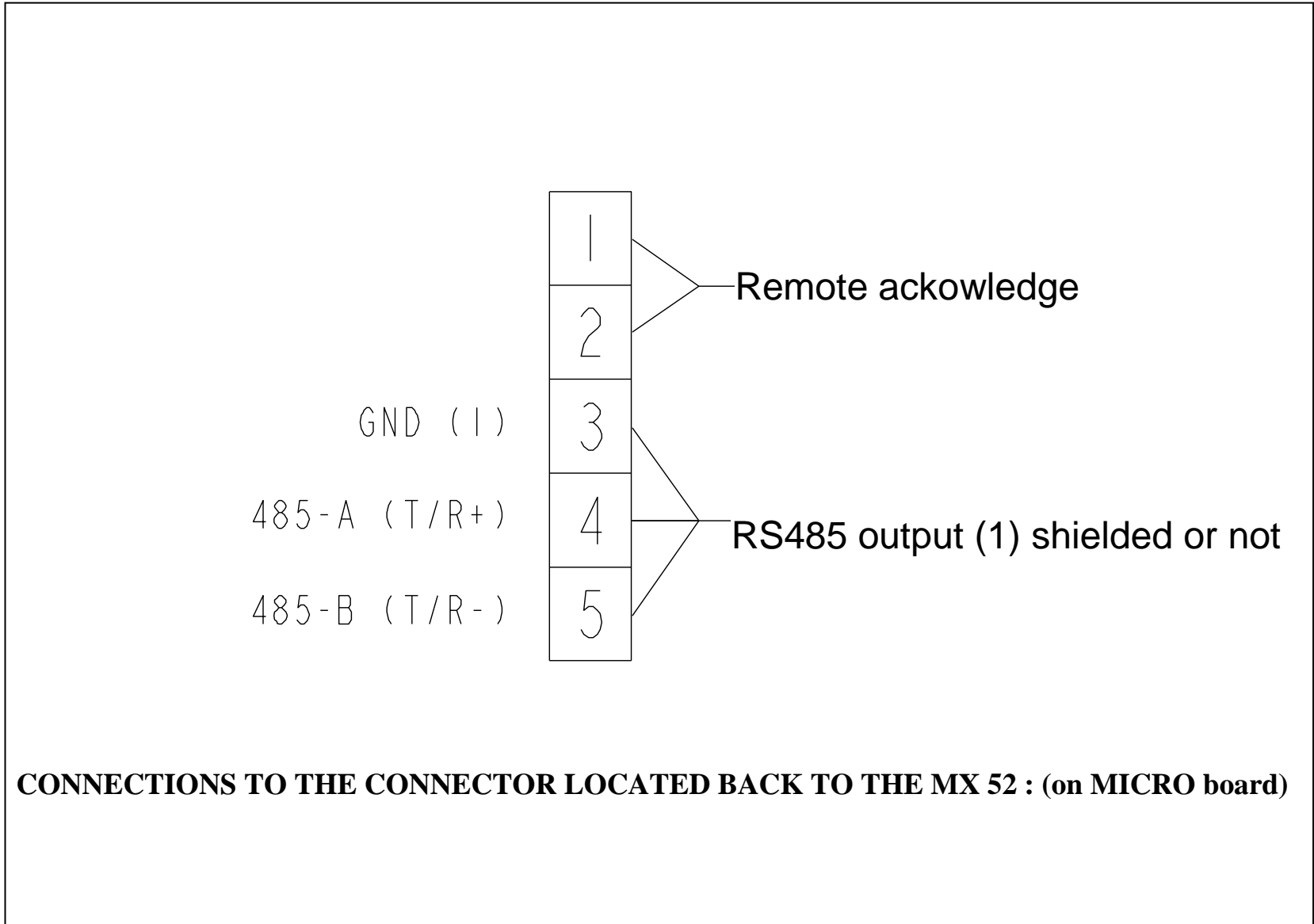

FIGURE 29



The Fixed Gas Detection Experts

EUROPEAN PLANT AND OFFICES

Z.I. Est – rue Orfila CS 20417 – 62027 Arras Cedex FRANCE

Tél: +33 (0)3 21 60 80 80 – Fax: +33 (0)3 21 60 80 00

Website: <http://www.oldhamgas.com>

AMERICAS

Tel: +1-713-559-9280
Fax: +1-281-292-2860
americas@oldhamgas.com

ASIA PACIFIC

Tel: +86-21-3127-6373
Fax: +86-21-3127-6365
sales@oldhamgas.com

EUROPE

Tel: +33-321-608-080
Fax: +33-321-608-000
info@oldhamgas.com